

SECTIONAL VALVES

VD10A - VD12A

Technical catalogue

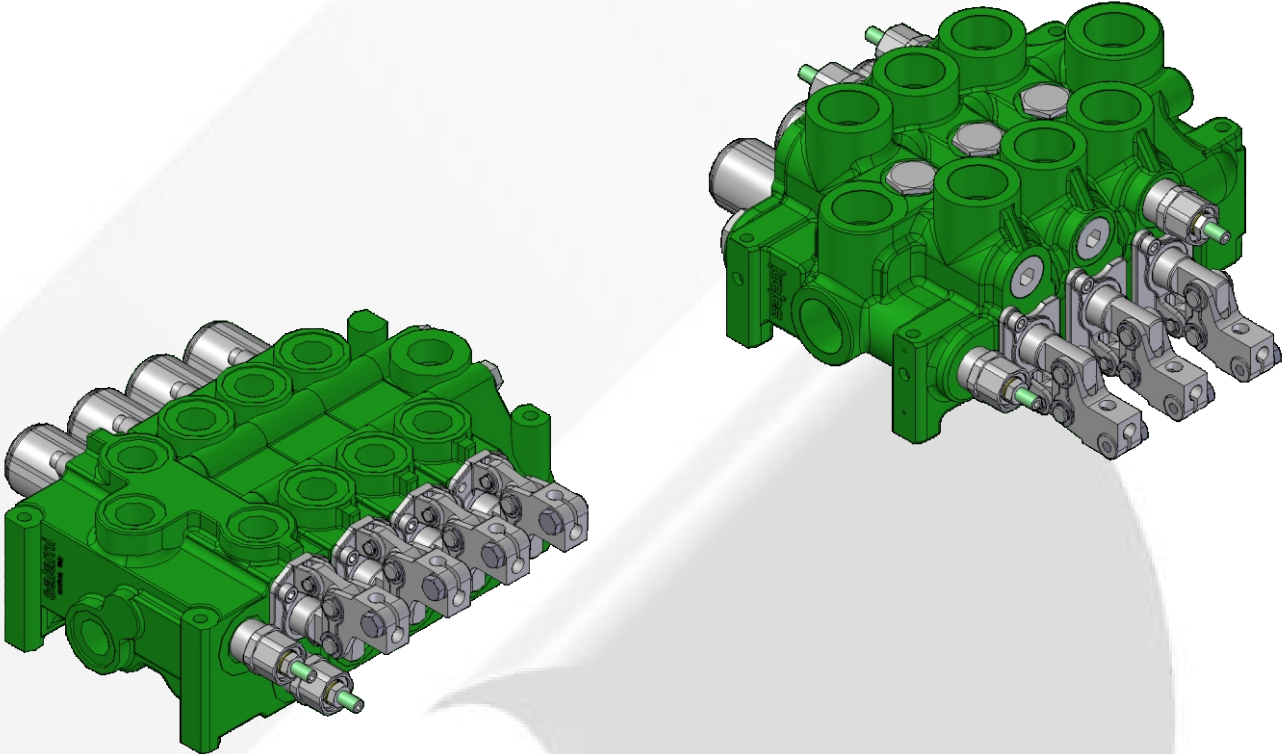

E0.24.0710.02.01

COMPANY
WITH QUALITY SYSTEM
CERTIFIED BY DNV
=ISO 9001/2000=



Page 1 - GENERAL INDEX

Page 2 - Features

Page 3 - Features

Page 4 - Features - VD10A technical data - VD12A technical data

Page 5 - Working conditions - Operating principle

Page 6 - Features - Circuit types - Hydraulic fluids

Page 7 - Features

Page 8 - VD10A - Dimensions from 1 to 8 working modules

Page 9 - VD10A - Performance data

Page 10 - VD10A - Available inlet and working module types

Page 11 - VD10A - End modules - Series circuit spools

Page 12 - VD12A - Dimensions from 1 to 8 working modules (standard release)

Page 13 - VD12A - Dimensions from 1 to 8 working modules (optimal release on request)

Page 14 - VD12A - Performance data

Page 15 - VD12A - Available circuit types

Page 16 - VD12A - Available circuit types

Page 17 - VD12A - End modules

Page 18 - Inlet modules (hydraulic circuits) - Main relief valves

Page 19 - Circuits types - Spool choice according to the inlet flow

Page 20 - Spool types

Page 21 - Auxiliary valves

Page 22 - Spool controls

Page 23 - Spool controls

Page 24 - Control side - Joystick for two spools

Page 25 - Spool positionings

Page 26 - Spool positionings

Page 27 - Mid modules

Page 28 - End modules

Page 29 - Standard shafts for protected lever code "NL" - Standard shafts for levers code "ML"

Page 30 - How to order VD10A-VD12A

Page 31 - WARRANTY

E0.24.1011.02.02

The data in this catalogue refers to the standard product.

The policy of Salami S.p.A. consists of a continuous improvement of its products. It reserves the right to change the specifications of the different products whenever necessary and without giving prior information.

If any doubts, please get in touch with our sales department.

FEATURES

GENERAL

Among all hydraulic directional control valves used in the field of mobile equipment applications, the spool valve is the most popular.

The sectional valve type allows construction flexibility. Salami directional control valves are modular construction and consist of an inlet section, up to 10 working sections and an outlet section. All these elements are secured in one block by means of tie-rods.

Working sections consist of:

- a special cast-iron body
- a spool with a hardened surface, anticorrosion treated
- a device for the operation of the spool
- a spool centering device.

FEATURES

Salami directional control valves have the following features :

- Modular construction up to 10 sections
- Hydraulic circuits between the sections
 - parallel circuit
 - series circuit
 - tandem circuit
- several valve types with different spool types
- possibility of adding a second valve
- spool construction in steel, hardened and chromium-plated to obtain a higher surface hardness and a better corrosion resistance
- minimum tolerance between the spools and the body to obtain a minimum internal leakage
- interchangeability of all the spools
- possibility of auxiliary valve either on port A or B or on both
- several spool controls

VALVE AND DEVICE TYPES

In order to meet the most stringent demands and to offer a wider range of applications, the following types of valves and devices are available :

• Valves

Direct main relief valve : Controls the maximum pressure in the circuit when one or more spools are on end stroke.

Piloted main relief valve : Controls the maximum pressure in the circuit when one or more spools are on end stroke. But, in comparison with the direct relief valve, it allows superior performances.

Port relief valve on port A or/and B: Set at a higher value (in comparison with the main relief valve), it protects the working ports from load induced pressures when the spool is in neutral position.

FEATURES

Anti-cavitation check valve on port A or/and B: Avoids cavitation in the system, created by the inertia, when the spool is in neutral position.

Port relief and anti-cavitation check valve on port A or/and B: Allows the same functions as the 2 preceding valves

Port relief valve : Limits the working pressure at a lower setting than the principal main relief valve; protects ports A and/or B

Double-single acting conversion valve : This manual selector changes the working section from double to single acting (A port).

Flow limiting valve : Reduces the flow on A and B ports (pressure compensated).

• Devices

Manual safety device : Avoids accidental operation of the spool.

Electric safety device : Avoids accidental operation of the spool, operation only possible with electrical signal present.

Control device for microswitches : For the operation of D.C. motor driven pumps at one or more rotation speeds.

Anti-tilt device : Returns the spool automatically to the neutral position when the pressure reaches a pre-set value to avoid cranes from becoming unstable

Hydraulic kick-out : Returns the spool automatically to the neutral position when the preset pressure of port A or B is exceeded

Venting valve: Located on the inlet module side, it allows venting of the total flow when no spool is activated. The valve can be opened hydraulically or electrically.

Hydraulic switch: Located on the inlet module side, activated manually, allows the hydraulic block of an actuator.

FEATURES

Nominal flow meaning: flow causing 1 bar (14.5 psi) pressure drop each section, with spools in neutral position

VD10A - TECHNICAL DATA

Spools	from 1 to 8 (for more working modules pls. contact our sales department)		
Nominal flow	Q	120 l/min	(32 gpm US)
Max flow*		140 l/min	(37 gpm US)
Max pressure	port P	280 bar	(4000 psi)
	ports A/B	315 bar	(4500 psi)
	port T*	25 bar	(363 psi)
In case of series circuit, the values of nominal/max. flow and max pressure are different, please see at page XX			
Internal leakage at 160 bar (2285 psi)	ports A/B → T	40 ÷ 55 cm ³ /min	(2.43 ÷ 3.34 cu.in./min)
For lower leakage please contact our sales department.			
Spool stroke (positions 1 and 2)		± 8.75 mm	(0,34 in.)
Spool stroke (position 4, float or regenerative)		± 8.75 + 6.75 mm	(0.34 + 0.26 in.)
*In case you need the max flow please contact our sales dept.			
*For higher back pressure please contact our sales dept.			
All technical data carried out using mineral oil with viscosity of 16 cSt and contamination level 19/16 as ISO 4406.			

VD12A - TECHNICAL DATA

Spools	from 1 to 8 (for more working modules pls. contact our sales department)		
Nominal flow	Q	180 l/min	(48 gpm US)
Max flow*		240 l/min	(63 gpm US)
Max pressure	port P	280 bar	(4000 psi)
	ports A/B	315 bar	(4500 psi)
	port T*	25 bar	(363 psi)
In case of series circuit, the values of nominal/max. flow and max pressure are different, please see at page XX			
Internal leakage at 160 bar (2285 psi)	ports A/B → T	40 ÷ 55 cm ³ /min	(2.43 ÷ 3.34 cu.in./min)
For lower leakage please contact our sales department.			
Spool stroke (positions 1 and 2)		± 8.75 mm	(0,34 in.)
Spool stroke (position 4, float or regenerative)		± 8.75 + 6.75 mm	(0.34 + 0.26 in.)
*In case you need the max flow please contact our sales dept.			
*For higher back pressure please contact our sales dept.			
All technical data carried out using mineral oil with viscosity of 16 cSt and contamination level 19/16 as ISO 4406.			

WORKING CONDITIONS

HYDRAULIC FLUID	Mineral oil according to DIN 51524
VISCOSITY	
Viscosity range	10 460 mm ² /sec. 0.015 0.713 sq.in./sec.
Optimal viscosity	12 75 mm ² /sec. 0.019 0.116 sq.in./sec.
TEMPERATURE	
Fluid range temperature	- 20 + 85° C - 4 + 185° F
Suggested range	+30 + 60° C +86 + 140° F
MAXIMUM CONTAMINATION LEVEL	NAS 1638: class 9 ISO 4406: 19/16
MAXIMUM PRESSURE ON TANK (T) PORT	20 bar 300 psi
ROOM TEMPERATURE	- 30 + 60° C - 22 + 140° F
WORKING LIMITS	See diagrams
PRESSURE DROPS	See diagrams
For operation with fire resistant fluid, please contact our sales department	

OPERATING PRINCIPLE

Salami directional control valves belong to the 6/3 (or 6/4) type; they can control 6 paths in 3 (or 4) spool positions simultaneously.

They are open circuit types: when the spool is in neutral position, the fluid flows directly to the tank with minimum internal pressure drops (approximately 1 bar / 14,5 psi for each spool at nominal flow).

When the spool is moved from this position, the central path is gradually throttled and the connection between pump and implement, through the corresponding port, is made.

When a pressure exceeds the value of the pressure existing in port A or B, the fluid flows through the check valve to the implement.

FEATURES

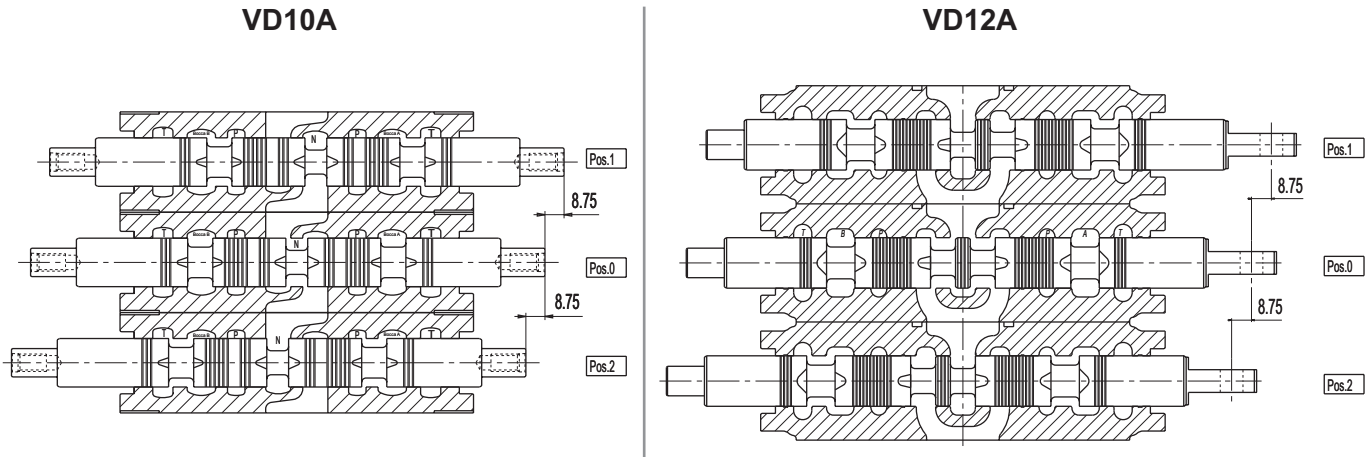

There are 3 characteristic phases in the spool stroke:

- a. the overlap phase (about 38% of the stroke) guarantees minimum internal leakages when it is in neutral position
- b. the progressive regulation phase (about 40% of the stroke) allows optimum metering
- c. residual phase (about 22% of the stroke)

CIRCUIT TYPES

For valve assemblies consisting of two or more working sections, the following types of circuits are available:

Parallel circuit : The spools, when activated simultaneously, will use full system pressure while dividing the available flow by the number of sections up to the maximum rating.

Series circuit : The spools, when activated simultaneously, will use full system flow while dividing the available pressure by the number of sections up to the maximum rating.

Tandem circuit : The actuated spool can use both full pressure and full flow. Down stream sections have no oil available.

Combined circuit : A combination of the above mentioned types of circuits.

HYDRAULIC FLUIDS

Usually a mineral-base oil with a good viscosity index should be used, preferably with good lubricating properties and corrosion, oxydation and foaming resistant.

Sometimes the fluids supplied by the manufacturers do not satisfy purity requirements (see WORKING CONDITIONS). It is therefore necessary to filter the fluid carefully before filling. Your supplier can give you the information about the NAS class of its fluids. To maintain the proper purity class, the use of filters of high dirt capacity with clogging indicator is recommended.

Under humidity conditions it is necessary to use igroscopic salts.

For operation with fire resistant and ecological fluids, please contact our technical department.

FEATURES

INSTALLATION

When proceeding to mount the unit on the structure and to connect adaptors to work ports, it is necessary to comply with the values of tightening torques as indicated in the maintenance book. The attachment of linkages to spools should not affect their operation. The mounting position can be vertical or horizontal.

FILTRATION

The contamination of the fluid circulating in the system greatly affects the life of the unit. Above all, contamination may result in irregular operation, wear of seals in valve housings and failures. Once the initial cleanliness of the system has been attained, it is necessary to limit any increase of contamination by installing an efficient filtration system.

PIPES

Pipes should be as short as possible, without restrictions or sharp bends (especially the return lines). Before connecting pipes to the adaptors of the corresponding components, make sure that they are free from burrs and other contamination.

As a first approximation, for a mobile machine with standard length pipes, pipe diameters should be selected on the ground of the flowing values of the fluid velocity :

6 to 10 m/sec : delivery pipe
3 to 5 m/sec. : outlet pipe

19.7 to 32.8 ft/sec : delivery pipe
9.9 to 16.4 ft/sec : outlet pipe

The lowest velocity in the pipes is required when the temperature range is wide and / or for continuous running.

Alternatively, the highest velocity is required when the temperature range is more limited and / or for intermittent operations.

PORTS

Following are standard ports. For other port types, please contact our sales department.

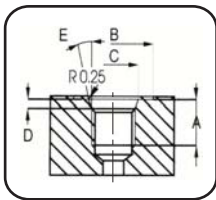

Dimensions		SAE UN-UNF (ISO 725)																
mm	in.	7/16-20 UNF SAE4		9/16-18 UNF SAE6		3/4-16 UNF SAE8		7/8-14 UNF SAE10		1 1/16-12 UN SAE12		1 5/16-12 UN SAE16		1 5/8-12 UN SAE20		1 7/8-12 UN SAE24		
A	12	0,47	13	0,51	15	0,59	17	0,67	20	0,79	20	0,79	20	0,79	20	0,79	20	0,79
B	21	0,83	25	0,98	30	1,18	34	1,34	41	1,61	49	1,92	58	2,28	65	2,56		
C	12,4	0,49	15,6	0,61	20,6	0,81	23,9	0,94	29,2	1,15	35,5	1,40	43,5	1,71	49,5	1,95		
D	2,4	0,09	2,5	0,10	2,5	0,10	2,5	0,10	3,3	0,13	3,3	0,13	3,3	0,13	3,3	0,13		
E			12°						15°									

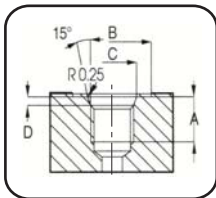

Dimensions		METRIC (ISO 6149)														
mm	in.	M18X1,5		M22X1,5		M27X2		M33X2								
		ISO 262	ISO 6149	ISO 262	ISO 6149	ISO 262	ISO 6149	ISO 262	ISO 6149							
A	14	0,55	14,5	0,57	16	0,63	16	0,63	18	0,71	19	1,75	20	0,79	19	0,75
B	27,5	1,08	29	1,14	31,5	1,24	34	1,34	37,7	1,48	40	1,57	45	1,77	46	1,81
C			19,8	0,78			23,8	0,94			29,4	1,16			35,4	1,39
D			2,4	0,09			2,4	0,09			3,1	0,12			3,1	0,12

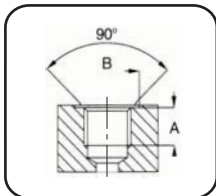

Dimensions		BSP (ISO 228)															
mm	in.	G 1/8		G 1/4		G 3/8		G 1/2		G 3/4		G 1		G 1 1/4		G 1 1/2	
A	10	0,39	14	0,55	14	0,55	16	0,63	18	0,71	20	0,79	22	0,87	24	0,94	
B (min)	15	0,59	19	0,75	23	0,91	27	1,06	33	1,30	40	1,57	50	1,97	56	2,20	

DIMENSIONS FROM 1 TO 8 WORKING MODULES

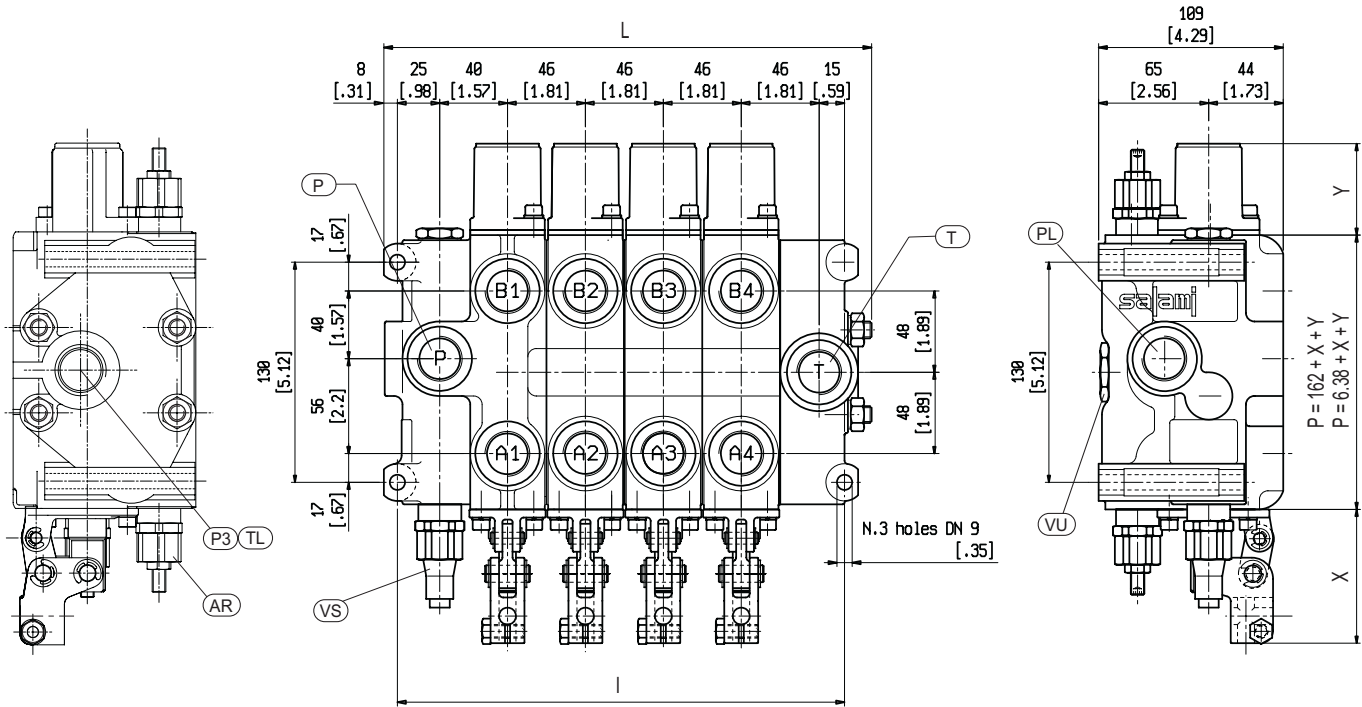

The drawing shown is just an example. The overall dimensions you read are valid for all the VD12A except the parametric dimensions "L" and "I" depending of the number of working sections. The parametric dimension "P" depends on a fixed dimension of 162 mm (6.38 in.) to which you have to add the "X" and "Y" dimensions that you can find in the spool controls and spool positionings pages.

INDEX:

- P** = top inlet port
- PL** = side inlet port
- T** = top outlet port
- TL** = side outlet port
- P3** = power beyond port
- A/B** = work ports
- VS** = main relief valve (adjustable)
- AR** = overload and anti-cavitation valve
- VU** = load check valve

Spools		1	2	3	4	5	6	7	8
I	mm	126	172	218	264	310	356	402	448
	in	4.96	6.77	8.58	10.39	12.20	14.01	15.82	17.63
L	mm	150	196	242	288	334	380	426	472
	in	5.90	7.71	9.52	11.33	13.14	14.96	16.77	19.44
Weight	Kg.	10.9	15.9	20.9	25.9	30.9	35.9	40.9	45.9
	lb.	23.98	34.98	45.98	56.98	67.98	78.98	89.98	100.98

For different size and thread ports, please contact our sales department

PORT SIZES	P - PL - P3	T	A - B
BSP ISO 228	G 3/4	G 1	G 3/4
SAE ISO 176	SAE#12 1-1/16 - 12 UN-2B	SAE#16 1-5/16 - 12 UN	SAE#12 1-1/16 - 12 UN-2B

For different port sizes, please contact our sales department.



PERFORMANCE DATA

Performance curves
carried out with
oil viscosity at 16 cSt

Internal leakages
A/B → T 35cm³ /min. (2.14 cu. in./min)
at 200 bar (2860 psi) and 16 cSt

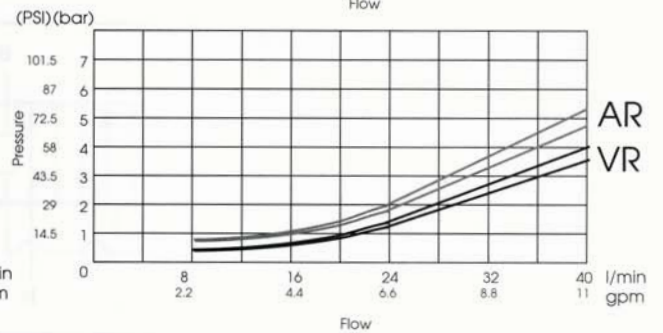
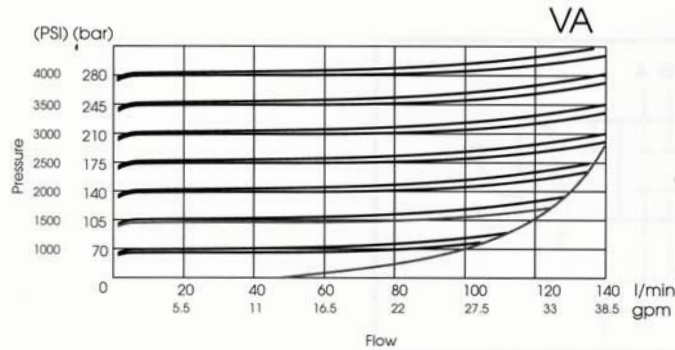
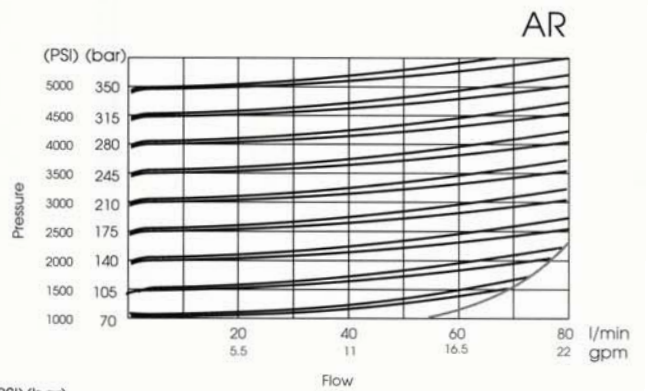
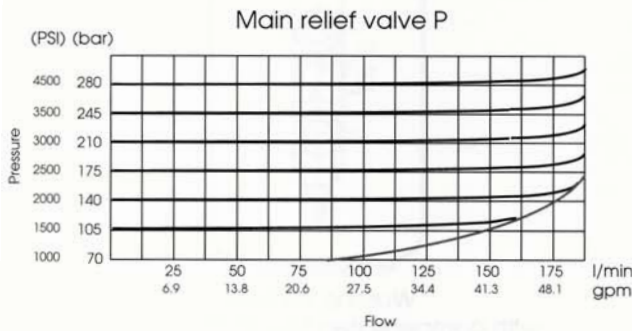
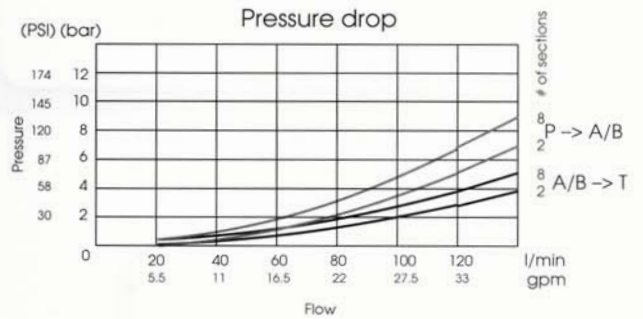
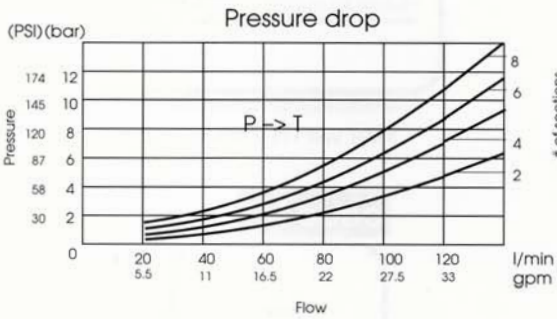
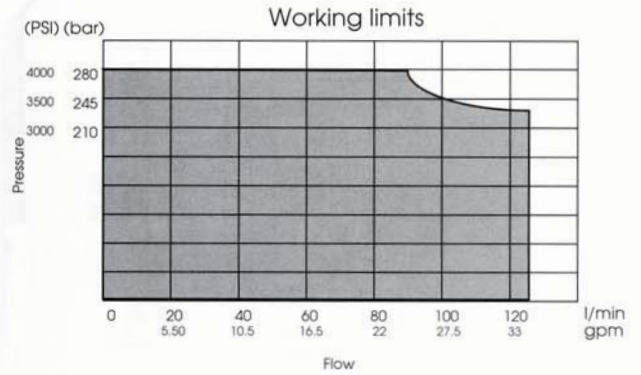
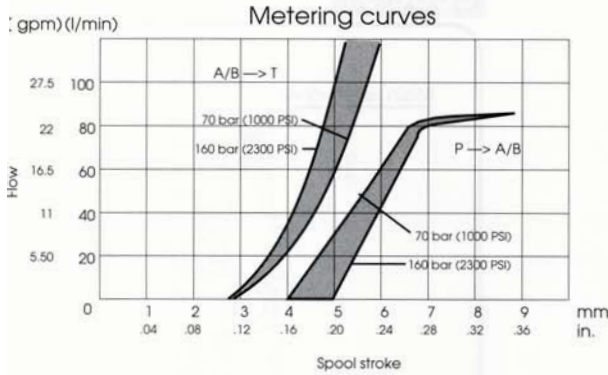

AVAILABLE INLET AND WORKING MODULE TYPES

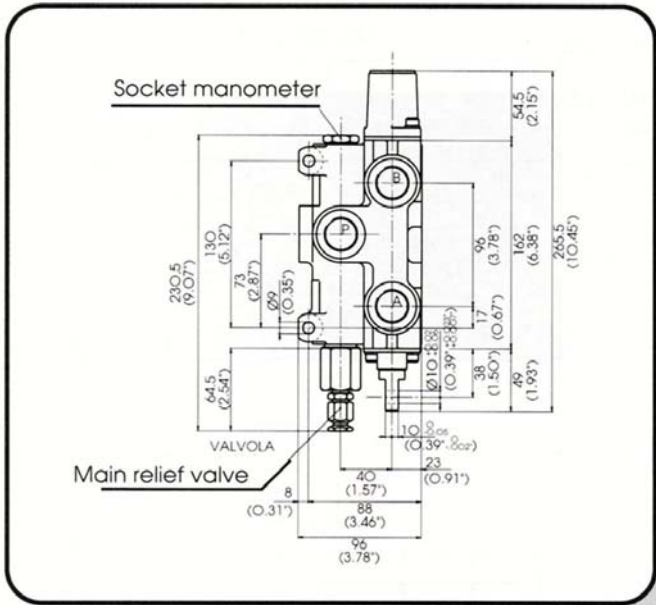

Inlet with working section

code 51

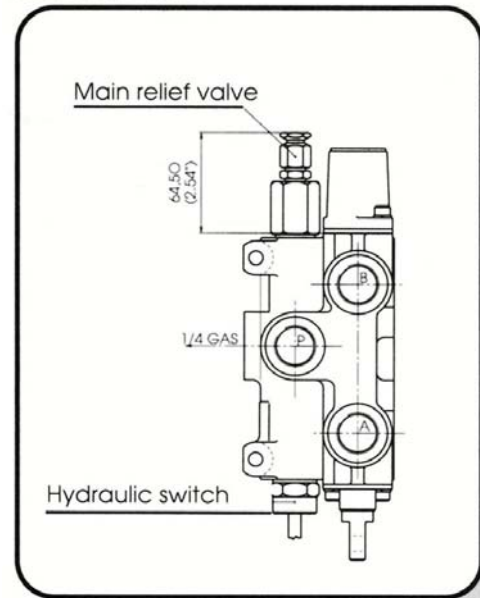

Inlet with hydraulic switch

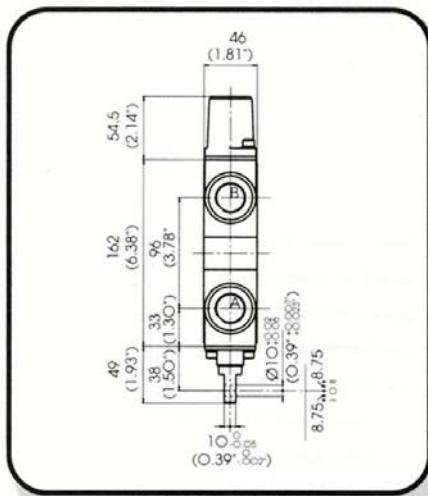

Working section

code LC

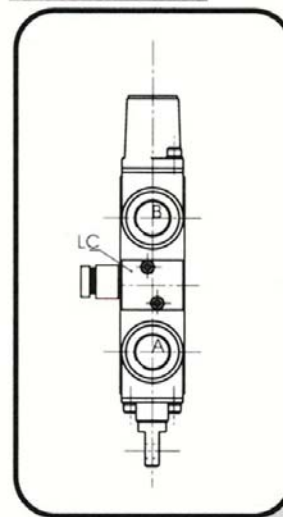

Working section
with compensated flow limiting valve

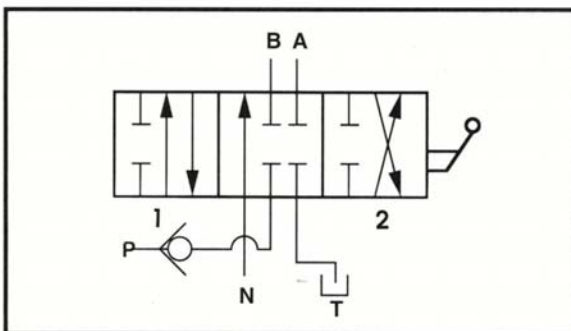

Double acting parallel circuit

END MODULES

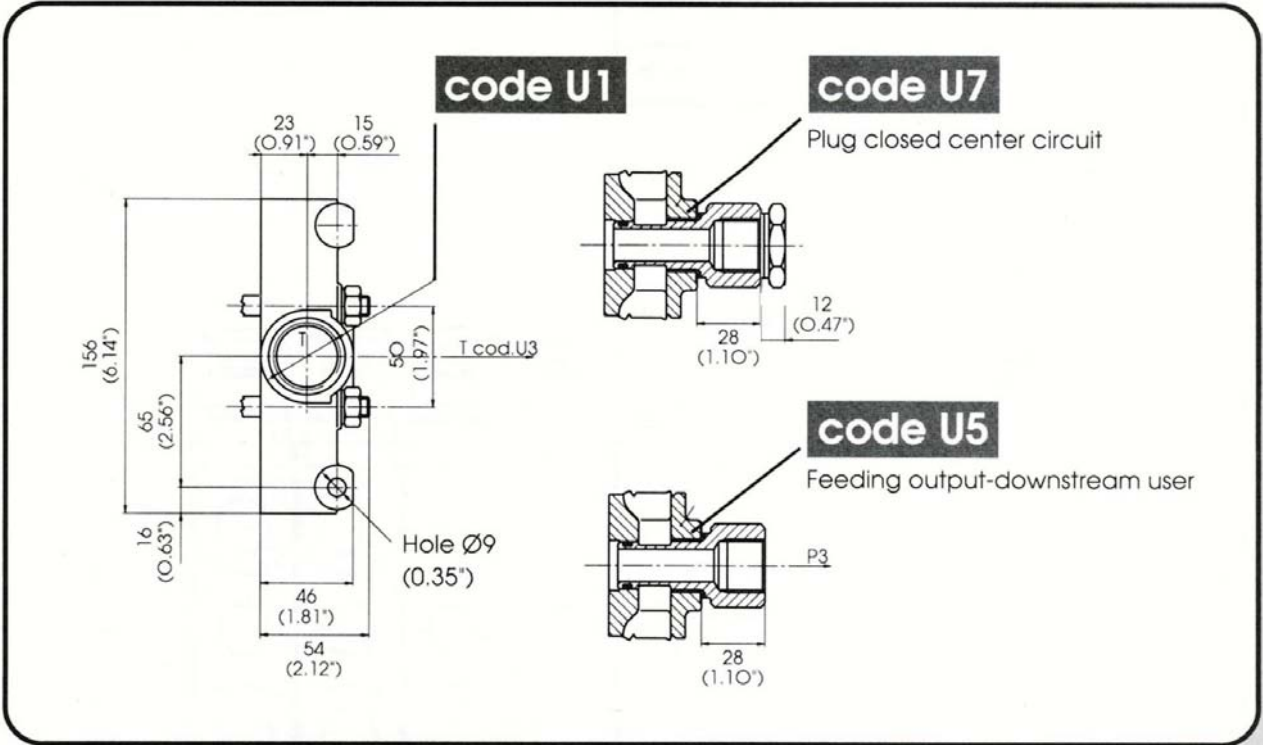

SERIES CIRCUIT SPOOL - FLOAT CIRCUIT SPOOL

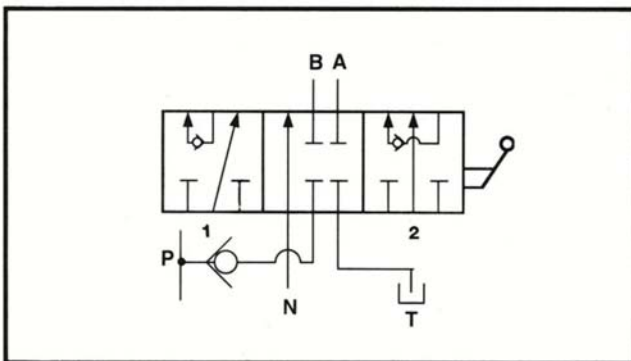

Double acting spool
for serie circuit

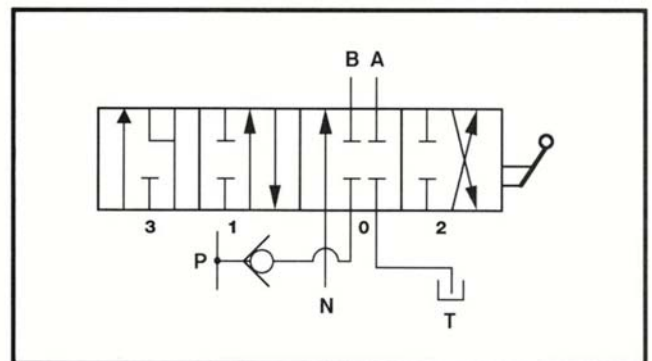

Double acting spool
with float spool position (spool out)

DIMENSIONS FROM 1 TO 8 WORKING MODULES RELEASE WITH CAST IRON INLET MODULE + WORKING SECTION (STANDARD)

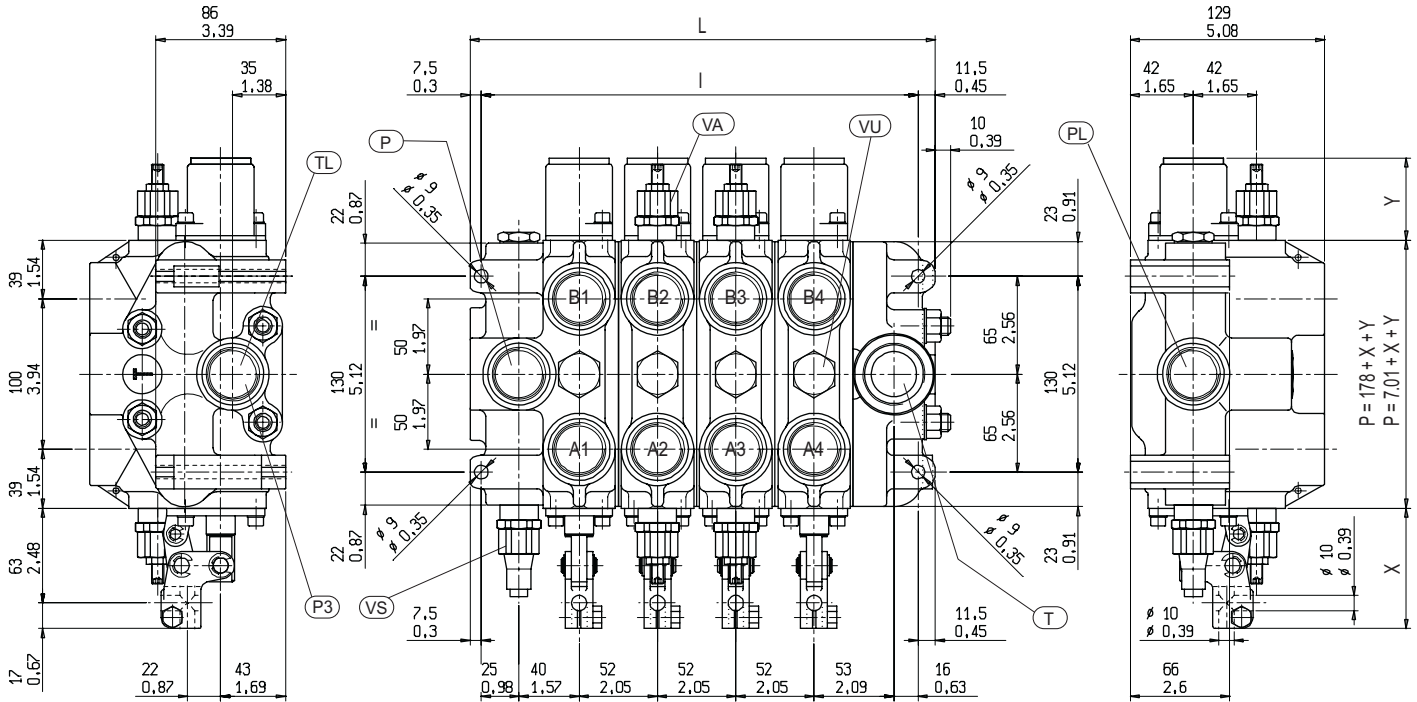

The drawing shown is just an example. The overall dimensions you read are valid for all the VD12A except the parametric dimensions "L" and "I" depending of the number of working sections. The parametric dimension "P" depends on a fixed dimension of 178 mm (7.01 in.) to which you have to add the "X" and "Y" dimensions that you can find in the spool controls and spool positionings pages.

INDEX:

- P** = top inlet port
- PL** = side inlet port
- T** = top outlet port
- TL** = side outlet port
- P3** = power beyond port
- A/B** = work ports
- VS** = main relief valve (adjustable)
- VA** = overload valve
- VU** = load check valve

Spools		1	2	3	4	5	6	7	8
I	mm	134	186	238	290	342	394	446	498
	in	5.27	7.32	9.37	11.42	9.10	13.46	17.56	19.61
L	mm	153	205	257	309	361	413	465	517
	in	6.02	8.07	10.12	12.16	14.21	16.26	18.31	20.35
Weight	Kg.	12.3	18.5	24.7	31	37.2	43.7	49.9	56.4
	lb.	27.12	40.79	54.46	68.36	82.03	96.36	110.03	124.36

For different size and thread ports, please contact our sales department

PORT SIZES	P - PL	T	TL - P3	A - B
BSP ISO 228	G 1	G 1	G 1	G 1
SAE ISO 176	SAE#16 1-5/16 - 12 UN	SAE#16 1-5/16 - 12 UN	SAE#16 1-5/16 - 12 UN	SAE#16 1-5/16 - 12 UN

On request you can have also T port **BSP ISO 228 - G 1 1/4**
or **SAE ISO 176 1-5/8 - 12 UN SAE 20**.

DIMENSIONS FROM 1 TO 8 WORKING MODULES
RELEASE WITH CAST IRON INLET MODULE SEPARATED (OPTIONAL ON REQUEST)

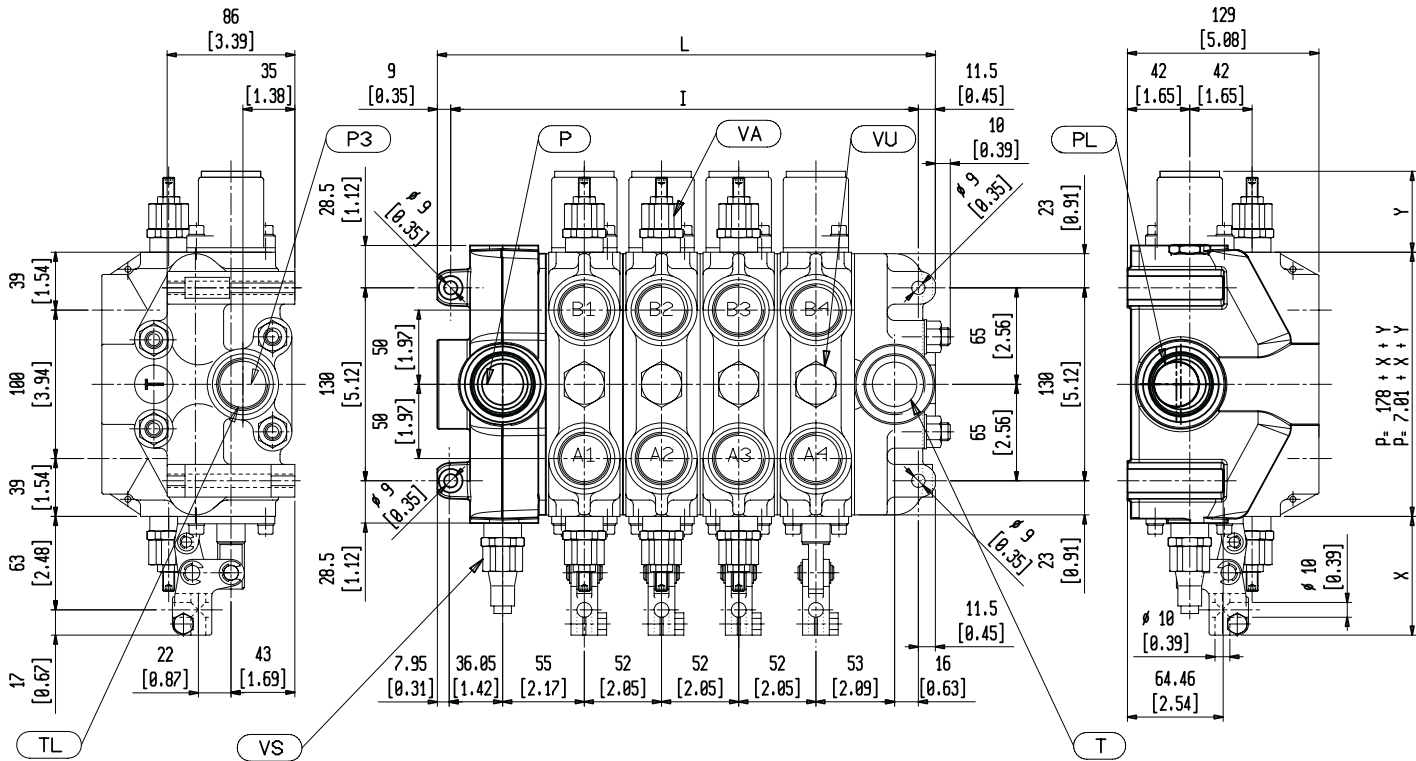

The drawing shown is just an example. The overall dimensions you read are valid for all the VD12A except the parametric dimensions "L" and "I" depending of the number of working sections. The parametric dimension "P" depends on a fixed dimension of 178 mm (7.01 in.) to which you have to add the "X" and "Y" dimensions that you can find in the spool controls and spool positionings pages.

INDEX:

- P** = top inlet port
- PL** = side inlet port
- T** = top outlet port
- TL** = side outlet port
- P3** = power beyond port
- A/B** = work ports
- VS** = main relief valve(adjustable)
- VA** = overload valve
- VU** = load check valve

Spools		1	2	3	4	5	6	7	8
I	mm	160	212	264	316	368	420	472	524
	in	6.3	8.35	10.4	12.44	14.5	16.53	18.58	20.63
L	mm	180.5	232.5	284.5	336.5	388.5	440.5	492.5	544.5
	in	7.11	9.15	11.2	13.25	15.3	17.34	19.4	21.44
Weight	Kg.	15.5	21.7	27.9	34.1	40.3	46.5	52.7	58.9
	lb.	34.17	47.84	61.51	75.17	88.85	102.51	116.18	129.85

For different size and thread ports, please contact our sales department

PORT SIZES	P - PL	T	TL - P3	A - B
BSP (ISO 228)	G 1	G 1	G 1	G 1
SAE (ISO 725)	SAE#16 1-5/16 - 12 UN	SAE#16 1-5/16 - 12 UN	SAE#16 1-5/16 - 12 UN	SAE#16 1-5/16 - 12 UN

On request you can also have P and T port **BSP (ISO 228) - G 1 1/4**
or **SAE (ISO 725) 1-5/8 - 12 UN SAE 20.**

PERFORMANCE DATA

Performance curves
carried out with
oil viscosity at 16 cSt

Internal leakages
A/B → T 35cm³ /min. (2.14 cu./min)
at 200 bar (2900 psi) and 16 cSt

Metering curves

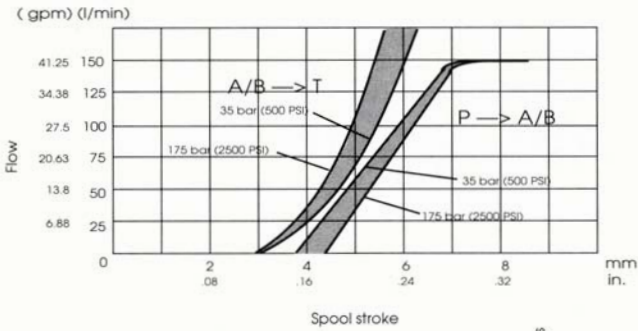

Working limits

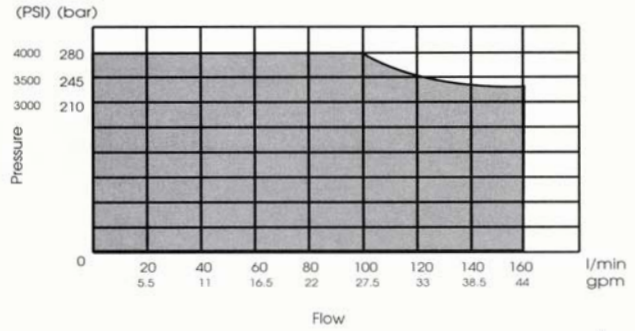

Pressure drop

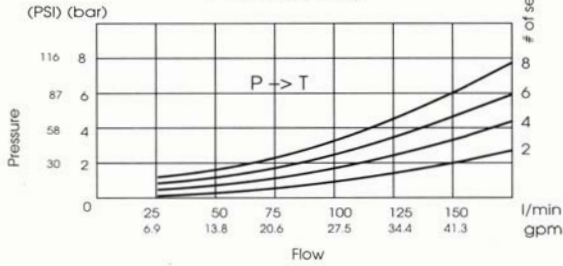

Pressure drop

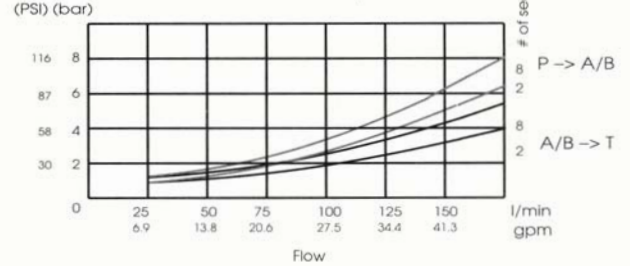

Main relief valve P

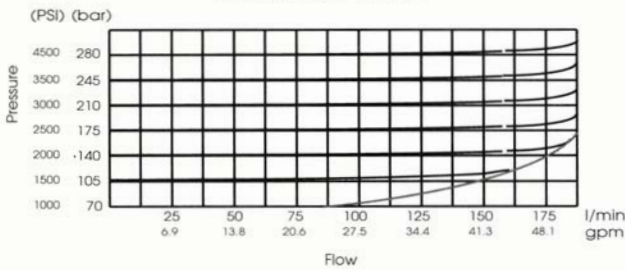

AR

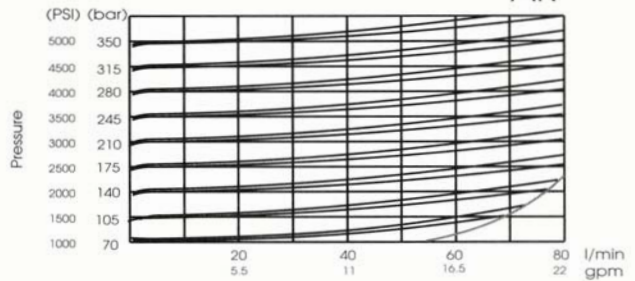

VA

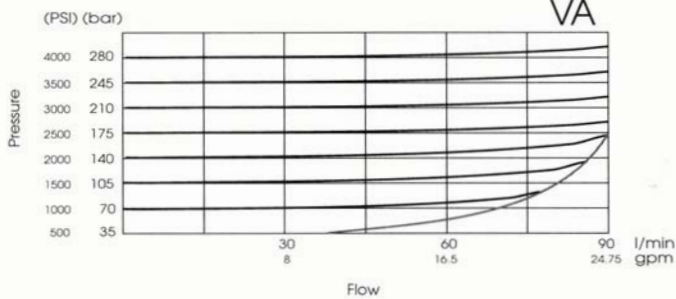

AVAILABLE CIRCUIT TYPES

PARALLEL CIRCUIT

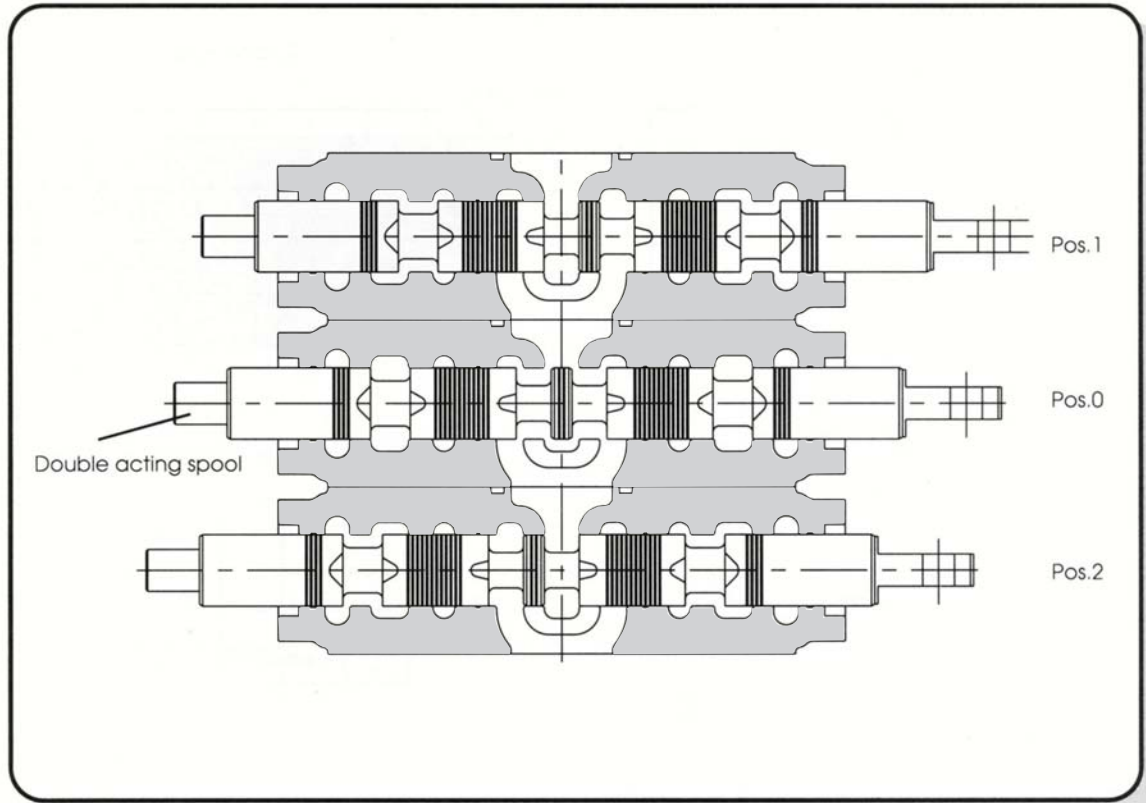

MIXED CIRCUIT

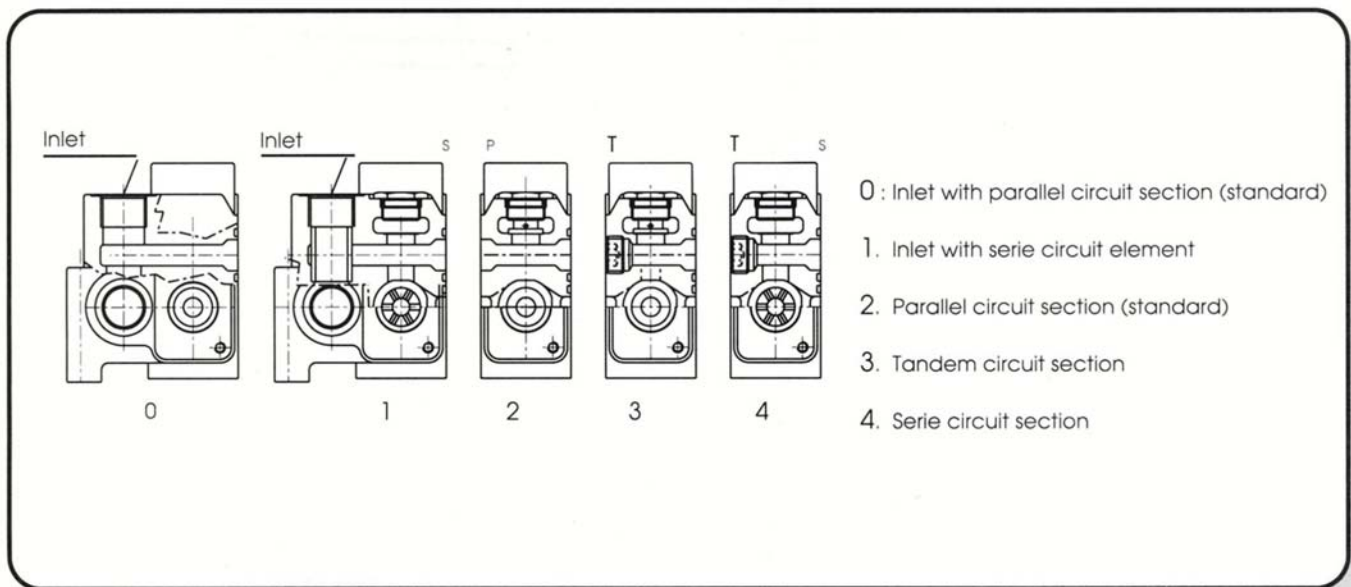

AVAILABLE CIRCUIT TYPES

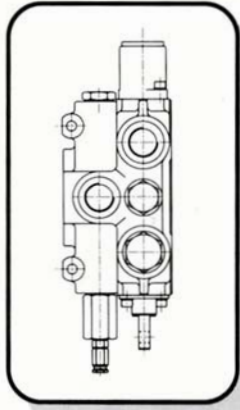

Inlet + working module

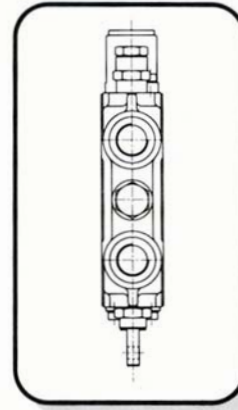

Working module

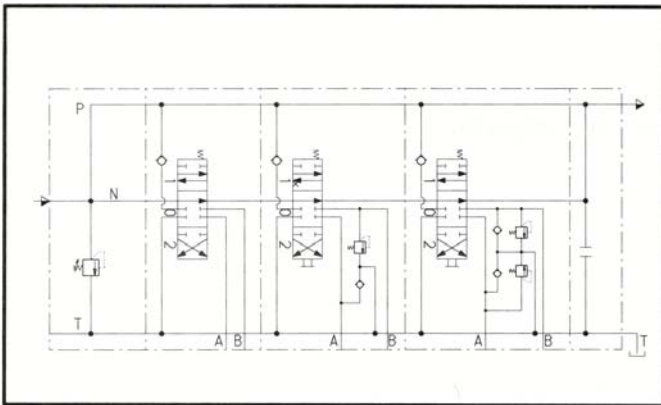

Parallel circuit

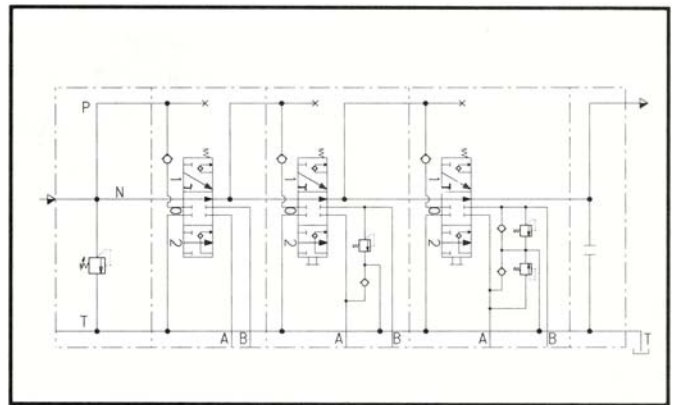

Series circuit

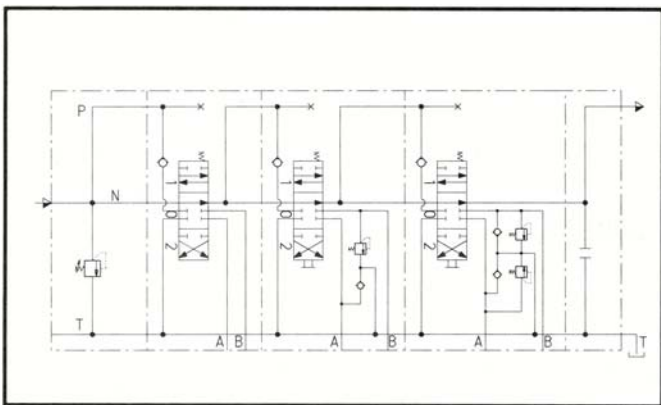

Tandem circuit

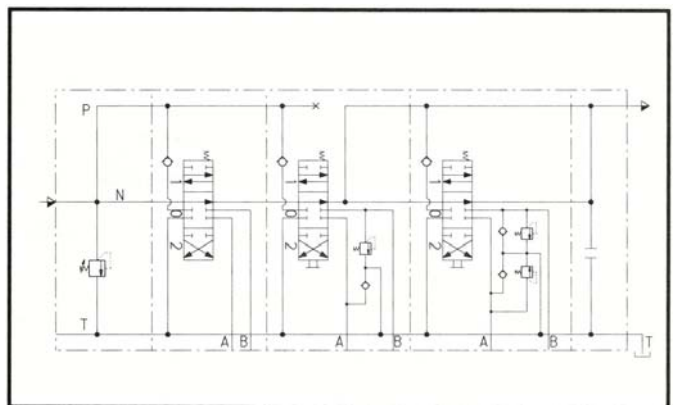

Mixed circuit

END MODULES

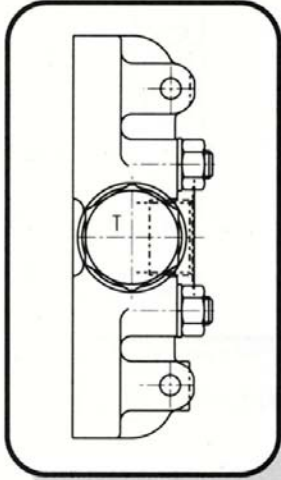

code U3

Side outlet port (plugged upper port)

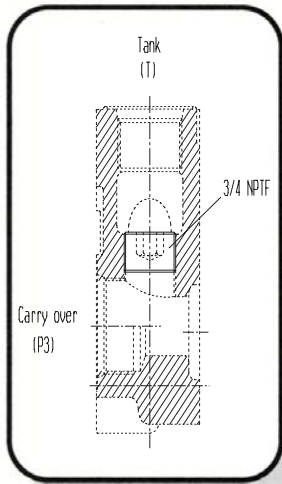

code U5

Power beyond configuration (P3 lateral)

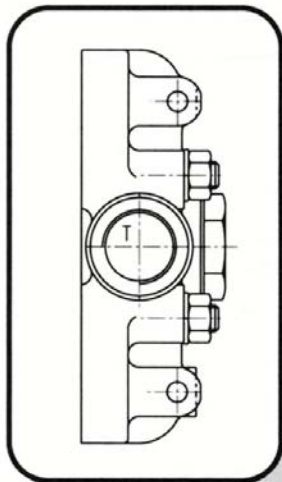

code U7

Closed center circuit configuration

INLET MODULES

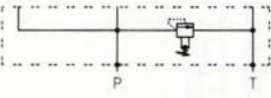
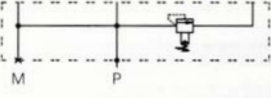
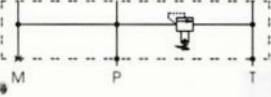
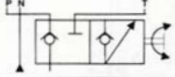
Code	Hydraulic symbol	Description	VD10A	VD12A
01		Top inlet port	•	•
02		Side inlet port (top port plugged)	•	•
03		Top and side inlet port	•	•
07		Top inlet and outlet port		
08		Side inlet and outlet port (top ports plugged)		
21		Top inlet port with gauge port	•	•
22		Side inlet port with gauge port	•	•
27		Top inlet and outlet port with gauge port		
28		Side inlet and outlet port with gauge port		
31	See page 14	Top inlet port with priority valve		
32	See page 14	Top inlet port with external priority valve		
51		Top inlet with hydraulic switch	•	

MAIN RELIEF VALVES

Code	Description	VD10A	VD12A
D	With direct main relief valve	•	•
P	With piloted main relief valve	•	•
W	Without main relief valve	•	•

CIRCUIT TYPES

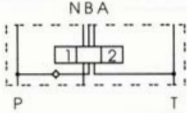
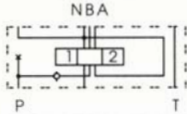
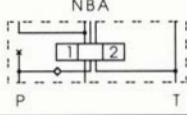
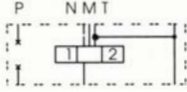
Code	Hydraulic symbol	Description			VD10A	VD12A
P		Parallel circuit			•	•
S		Series circuit			•	•
T		Tandem circuit			•	•
H		Circuit for hydraulic hammer				

SPOOL CHOICE ACCORDING TO THE INLET FLOW

Code	Description			VD10A	VD12A
A	Nominal flow			•	•
C	2 / 3 of nominal flow			•	•

SPOOL TYPES

Code	Hydraulic symbol	Description	VD10A	VD12A
01		Double acting spool	•	•
02		Double acting motor spool	•	•
03		Double acting motor spool (B port blocked)	•	•
04		Double acting motor spool (A port blocked)	•	•
05		Single acting spool A working port	•	•
06		Single acting spool B working port	•	•
11		Double acting spool with third float position (spool in)		
12		Double acting spool with third float position (spool out)	•	•
17		Double acting spool with regenerative function in position 2 (spool in)		•
18		Double acting spool with regenerative function in position 1 (spool out)		•

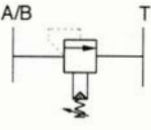
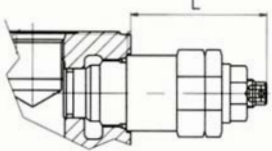
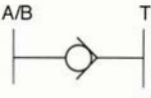
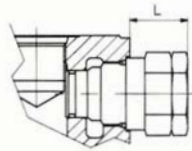
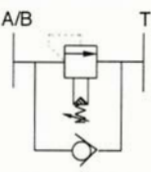
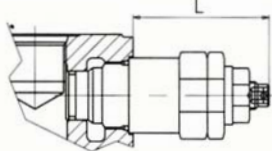
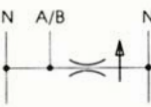
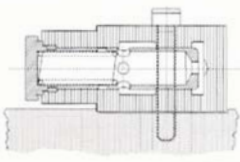
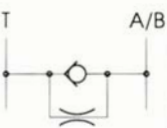
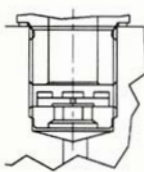
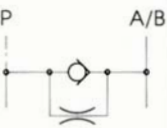
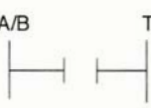

AUXILIARY VALVES

Code	Hydraulic symbol	Description				VD10A	VD12A
VA		Overload valve				• L=55 2.17"	• L=55 2.17"
VR		Anticavitation valve				• L=7 0.28"	• L=7 0.28"
AR		Overload and anticavitation				• L=71 2.80"	• L=71 2.80"
LC		Flow limiting valve				•	•
ST		Flow restrictor				Available like carriage	Available like carriage
SP		Flow restrictor					
PR		Prearranged for auxiliary valves (plugged)				•	•

The valve code LC needs a modification on the module.
The valves code SA and SB are not included in the codification.
If one of those codes are requested, please add a technical note.

SPOOL CONTROLS

Code	Hydraulic symbol	Description				VD10A	VD12A
SL		Without lever				L=38 1.50" • ø=10 0.39"	L=38 1.50" • ø=10 0.39"
NL		With protected lever				• L=102 4.02"	• L=102 4.02"
NP		With protector lever (only when there are no auxiliary valves)					
ML		Not protected clamp levers				• L=79 3.11"	• L=79 3.11"
L1		Cross lever for 2 spools with fulcrum on up-stream spool (see pag. 40)				• L=80 3.15"	• L=80 3.15"
L2		Cross lever for 2 spools with fulcrum on down-stream spool (see pag. 40)		• L=80 3.15"	• L=80 3.15"		
IF		Hydraulic proportional control with third float position (spool out)				• L=124 4.9	• L=124 4.9
TC		Cable control (with mounting kit on directional control valve)				• L=90 3.54"	• L=90 3.54"
IP		Hydraulic proportional min: 57 psi (4 bar) max: 357 psi (25 bar)				• L=75 2.95"	• L=75 2.95"
PP		Pneumatic proportional min: 35 psi (2.5 bar) max: 85 psi (6 bar)				• L=127 5	• L=127 5
PO		Pneumatic ON-OFF min: 50 psi (3.5 bar)		• L=127 5	• L=127 5		

* Without rubber protection



SPOOL CONTROLS

Code	Hydraulic symbol	Description				VD10A	VD12A
PQ		Pneumatic ON-OFF for pos. 3 6 bar \pm 0.5 87 psi \pm 7					
E1		Electric 3 positions ON-OFF 12V c.c.					
E2		Electric 3 positions ON-OFF 24V c.c.					
E3		Electric ON-OFF 12V c.c.					
E4		Electric push ON-OFF 24V c.c.					
H1		Electro hydraulic ON-OFF 12V c.c. (max 25 bar/362 PSI)				•	•
H2		Electro hydraulic ON-OFF 24V c.c. (max 25 bar/362 PSI)				•	•
P1		Electro pneumatic ON-OFF 12V c.c. (max 9 bar/130 PSI \pm 7)				•	•
P2		Electro pneumatic ON-OFF 24V c.c. (max 9 bar/130 PSI \pm 7)				•	•

CONTROL SIDE

Standard configuration
for :

**VD10A
VD12A**

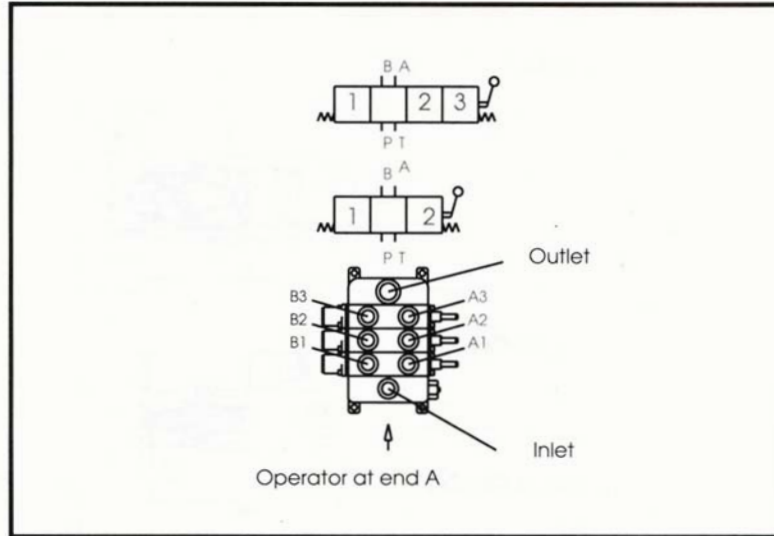

For other configurations, please contact our technical department.

JOYSTICK FOR TWO SPOOLS

code L1

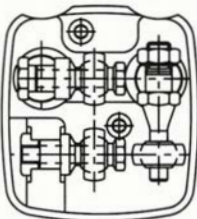
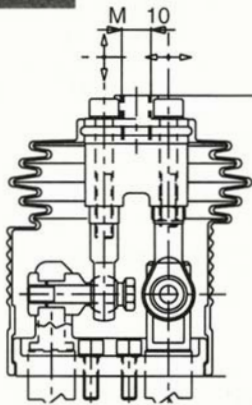

INLET SPOOL 1 SPOOL 2

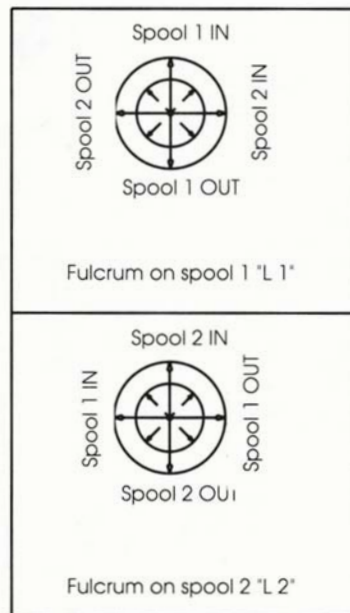

code L2

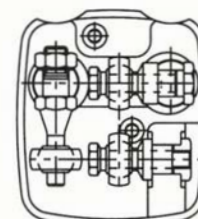
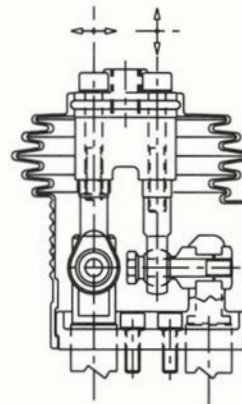







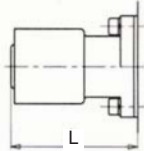
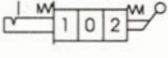
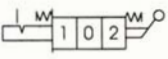
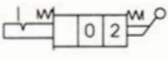
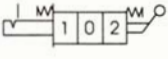

INLET SPOOL 1 SPOOL 2

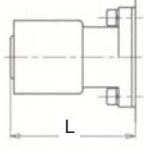
SPOOL POSITIONINGS

Code	Hydraulic symbol	Description				VD10A	VD12A
CO		With detent on each position				• L=66,5 2.58"	• L=66,5 2.58"
C2		Spring centered to neutral				• L=54 2.13"	• L=54 2.13"
C3		Spring centered to neutral with double control (screw tap)				• L=87 3.43"	• L=87 3.43"
C4		Spring centered to neutral with double control (screw female)					
C5		Two positions (neutral/spool-in) with spring return in neutral				• L=54 2.13"	• L=54 2.13"
C6		Two positions (neutral/spool-out) with spring return in neutral				• L=54 2.13"	• L=54 2.13"
CE		Pre-arrangement for electrical device				• L=98 3.86"	• L=98 3.86"
CM		Microswitch (for each spool) to start an electric motor (Max current = 10A at 250 Vca)				• L=98 3.86"	• L=98 3.86"
CW	The same assembling of "CM" with waterproof microswitch						

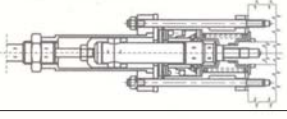
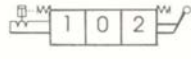
SPOOL POSITIONINGS

Code	Hydraulic symbol	Description				VD10A	VD12A
R2		Detent in spool in-out with spring return in neutral				• L=85 3.35"	• L=85 3.35"
R4		Detent on spool out with spring return in neutral				• L=85 3.35"	• L=85 3.35"
R5		Detent on spool in with spring return in neutral				• L=85 3.35"	• L=85 3.35"
R6		Detent on spool in 2 positions with spring return in neutral					
R7		Detent on spool out 2 positions with spring return in neutral				• L=85 3.35"	• L=85 3.35"
F5		Detent on float spool out with spring return in neutral				• L=89 3.50"	• L=89 3.50"
F6		Detent on float and spool out with spring return in neutral				• L=89 3.50"	• L=89 3.50"
F7		Detent on float and spool in with spring return in neutral				• L=89 3.50"	• L=89 3.50"
F8		Detent on float spool in-out with spring return in neutral				• L=89 3.50"	• L=89 3.50"
D1		Cable remote control cap side				• L=144 5.67"	• L=144 5.67"
G2		Detent on spool in-out position with hydraulic kick-out				• L=95 3.7	• L=95 3.7

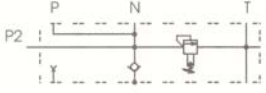
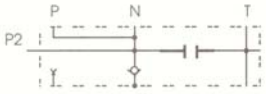
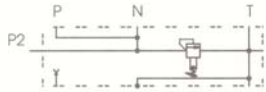
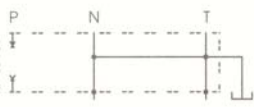

MID MODULES

Code	Hydraulic symbol	Description			VD10A	VD12A
11		Mid inlet for second pump with combining flows and relief valve			*	*
12		Mid inlet for second pump with combining flows without main relief valve			*	*
13		Mid inlet for second pump with separating flows and main relief valve			*	*
14		13 + gauge port			*	*
19		Mid outlet			*	*

For the codes 11 - 13 - 14 , add in sequence the valve type (P = piloted or D = direct) and the corresponding setting (in bar).

EX : 14D250 = Mid inlet with separated flows and direct relief valve set at 250 bar (3600 psi) with gauge port.

*Available for quantity, please contact our sales dept.

END MODULES

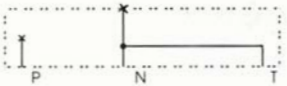
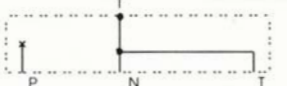
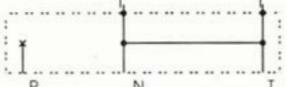
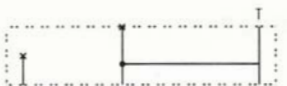
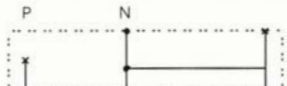
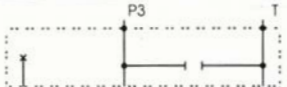
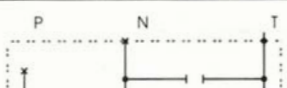
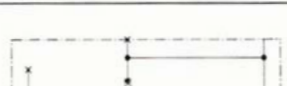
Code	Hydraulic symbol	Description			VD10A	VD12A
U0		Without port				
U1		Top outlet port			•	•
U2		Top and side outlet port			•	•
U3		Side outlet port (top port plugged)			•	•
U4		Top outlet port (side port plugged)			•	•
U5		Power beyond configuration (side P3)			•	•
U7		Closed center circuit configuration			•	•
U8		Top outlet section with back-pressure valve on neutral			•	•

STANDARD SHAFTS FOR PROTECTED LEVERS CODE NL

			VD10A	VD12A	
M			M10	M10	
L			240mm - 9.5°	240mm - 9.5°	

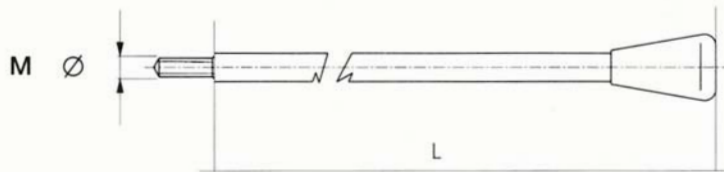

code LA

STANDARD SHAFTS FOR LEVERS CODE ML

			VD10A	VD12A
∅			10	10
L			240	240

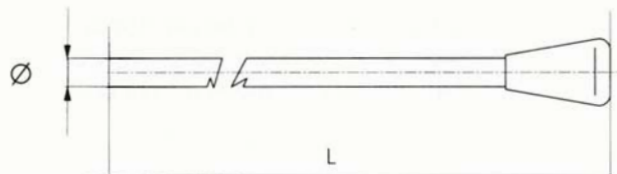

code LB

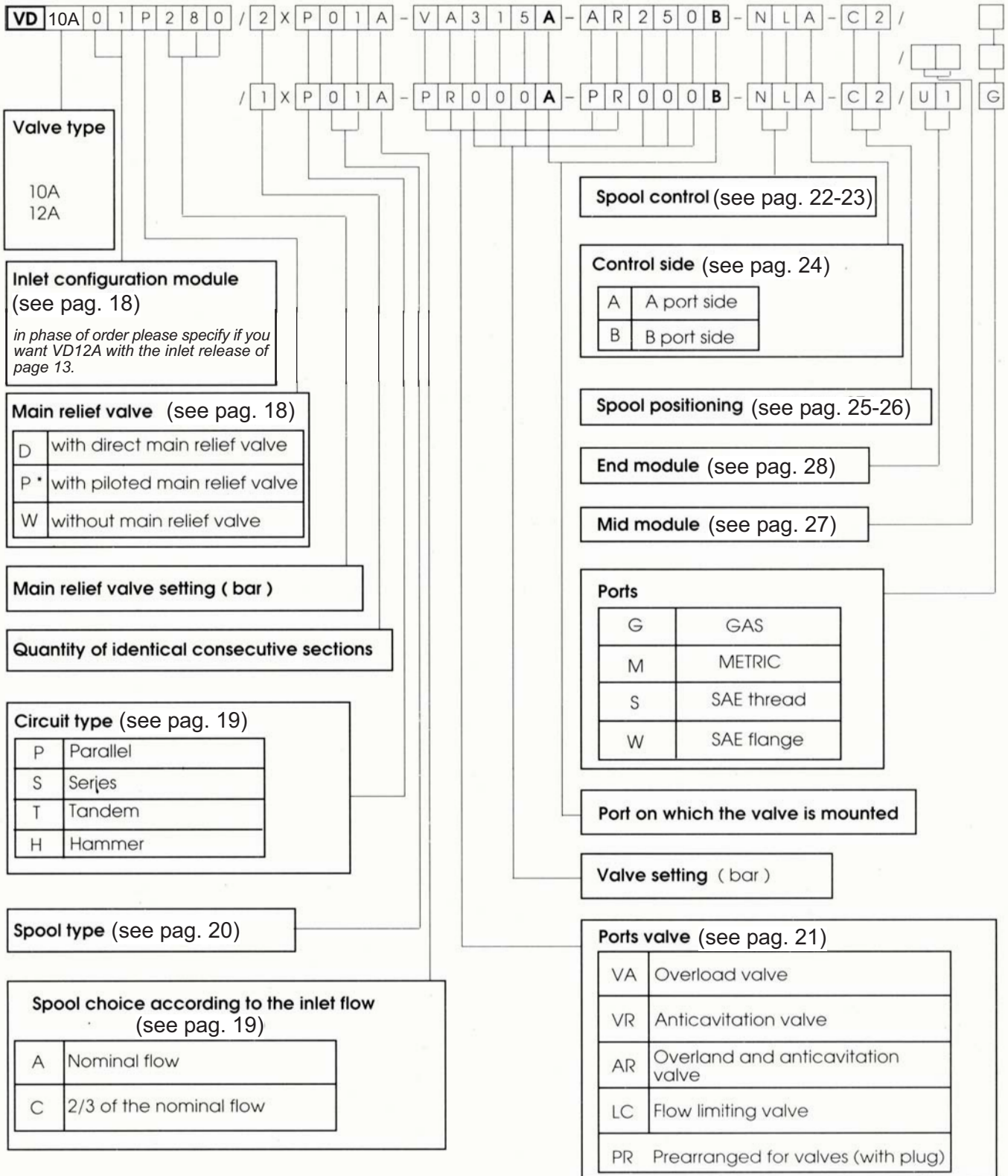

WARRANTY

- We warrant products sold by us to be free from defects in material and workmanship.
- Our sole obligation to buyer under this warranty is the repair or replacement, at our option, of any products or parts thereof which, under normal use and proper maintenance, have proven defective in material or workmanship, this warranty does not cover ordinary wear and tear, abuse, misuse, overloading, alteration.
- No claims under this warranty will be valid unless buyer notifies SALAMI in writing within a reasonable time of the buyer's discovery of such defects, but in no event later than twelve (12) months from date of shipment to buyer.
- Our obligation under this warranty shall not include any transportation charges or cost of installation, replacement, field repair, or other charges related to returning products to us; or any liability for direct, indirect or consequential damage or delay. If requested by us, products or parts for which a warranty claim is made are to be returned transportation prepaid to our factory. The risk of loss of any products or parts thereof returned to SALAMI will be on buyer.
- No employee or representative is authorized to change any warranty in any way or grant any other warranty unless such change is made in writing and signed by an officer of SALAMI.



SALAMI spa
via Emilia Ovest 1006
41100 Modena Italy
telefono +39-059-387411
telefax +39-059-387500
export@salami.it - www.salami.it



SALAMI ITALIA srl
strada Pelosa 183
S. Pietro in Trigogna VI Italy
telefono +39-0444-240080
telefax +39-0444-240204
salami.italia@salami.it



SALAMI ESPAÑA
Poligono Industrial Armenteres
C/Primer de Maig, 18, Nave 4
08980 San Feliu de Llobregat
Barcelona
telefono +34-93-6327288
telefax +34-93-6667826
info@salamispain.com



SALAMI FRANCE
22, rue Louis Saillant
69120 Vaux en Velin
Lyon
telefono +33-04-78809941
telefax +33-04-78803669
e.pasian@wanadoo.fr



149 S0. Chenango St. Ext.,
GREEN, NY 13778
Tel.: +1-607-6565702
Fax.: +1-607-6565704
info@salamihydraulics.com